

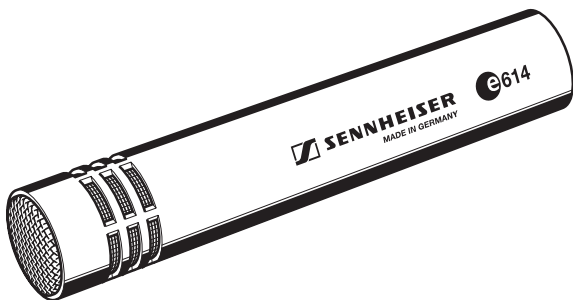





Bedienungsanleitung  
Instructions for use  
Notice d'emploi  
Istruzioni per l'uso  
Instrucciones para el uso  
Gebruiksaanwijzing



Bedienungsanleitung.....	3
Instructions for use .....	9
Notice d'emploi .....	15
Istruzioni per l'uso.....	21
Instrucciones para el uso.....	27
Gebruiksaanwijzing.....	33

## 614

The super-cardioid  614 is a pre-polarised condenser microphone designed for demanding applications which require a wide frequency response, high sound pressure level, fast transient response and a compact design. With its frequency response of 40 Hz to 20 kHz, the  614 is able to capture the full sound of the instrument, while its super-cardioid pick-up pattern isolates the microphone from other on-stage signals.

An excellent microphone for overheads, hi-hat and percussions, the  614 is also an ideal choice for woodwind and string instruments. Its excellent acoustic properties also make it a valuable tool for home recording, the project studio and live stereo pair recording.

### Features

- Rugged design
- Excellent directivity across the whole frequency range
- Full, natural sound
- High maximum sound pressure level
- Wide frequency response

## Delivery includes

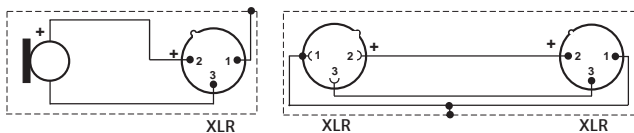

- e614 microphone
- Pouch
- MZQ 100 microphone clamp
- Instructions for use
- Warranty Certificate

## Pin assignment of XLR-3 connector



# Positioning the microphone

## Drums / Percussions

Position	Resulting sound	Commentary
	Natural, clear sound	<p>Position the microphone a few centimetres above the outer edge of the hi-hat aiming down. If necessary, remove unwanted low-frequency signal portions by high pass filtering.</p> <p>Attention: When closing the hi-hat, a strong air current is created on the edge. If the microphone is positioned too close to the edge, interfering noise due to the air current can occur.</p>
	More fundamental, little overtones	

In order to prevent interference due to crosstalk between adjacent sound sources, try to position the microphone so that the interfering sound source is located in the angle area of the highest cancellation of the microphone (approx. 135°; see polar diagram)

## Polar diagram

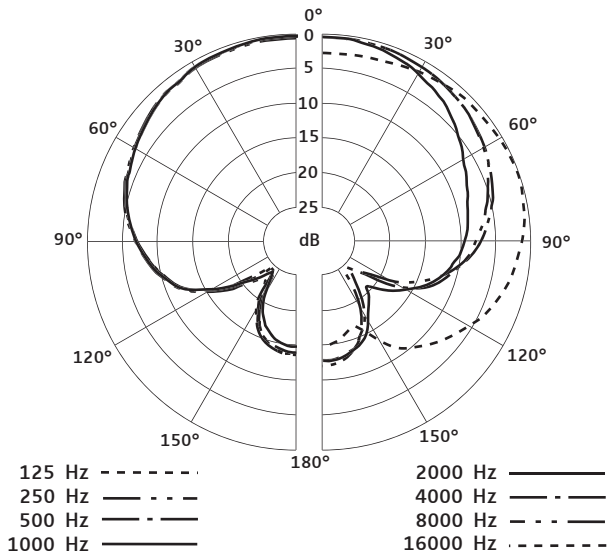

## Frequency response curve

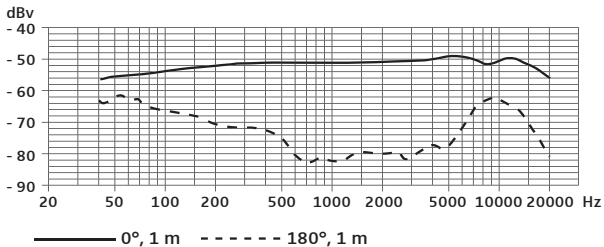

## Specifications

Transducer principle	pre-polarised condenser microphone
Frequency response	40....20,000 Hz
Pick-up pattern	super-cardioid
Sensitivity (free field, no load at 1 kHz)	3 mV/Pa
Max. sound pressure level at 1 kHz	139 dB/SPL
Nominal impedance	50 $\Omega$
Min. terminating impedance	1 k $\Omega$
Phantom powering	12 – 52 V / 3 mA
Connector	XLR-3
Dimensions	$\emptyset$ 20 mm, L 100 mm
Weight	93 g

## Overview of microphone applications

Application	Variant										
	e602	e604	e606	e608	e614	e815	e825	e835	e840	e845	e865
Vocals						x	x	x	x	x	x
Choirs					x						
Studio, acoustic instruments					x						
Orchestra					x						
Brass / Saxophone	x	x		x							
Acoustic guitar					x						
Acoustic bass					x						
Guitar amplifiers			x								
Bass amplifiers	x										
Leslie	x	x	x								
Piano, grand piano					x						
Kick drums	x										
Snare drums		x	x	x							
Rack toms		x	x	x							
Floor toms	x	x	x								
Congas		x	x	x							
Cymbals					x						
Percussion		x	x	x	x						
Overheads					x						





### Konformitätserklärung

Sennheiser electronic GmbH & Co. KG erklären, dass dieses Gerät die anwendbaren CE-Normen und Vorschriften erfüllt.

### Approval

Sennheiser electronic GmbH & Co. KG declare that this device is in compliance with the applicable CE standards and regulations.

### Certification

Sennheiser electronic GmbH & Co. KG déclarons que cet appareil est en conformité avec les normes CE.

### Certificazione

Sennheiser electronic GmbH & Co. KG dichiara che questo apparecchio risponde alle normative e alle prescrizioni CE applicabili.

### Autorizacion

Sennheiser electronic GmbH & Co. KG declara que este aparato cumple las normas y directrices de la CE aplicables.

### Vergunning

Sennheiser electronic GmbH & Co. KG verklaren, dat dit toestel voldoet aan de toepasselijke CE-normen en voorschriften.

**Diese Service-Nummer gilt nur für Deutschland**

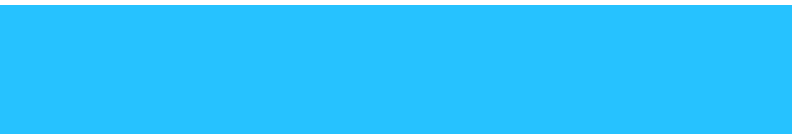

Sennheiser electronic GmbH & Co. KG  
30900 Wedemark, Germany  
Phone +49 (5130) 600 0  
Fax +49 (5130) 600 300  
[www.sennheiser.com](http://www.sennheiser.com)